

COTRAL, VENDER É A ARTE DE CRIAR!

COTRAL

By **Raisman**[®]



Transformar e servir sempre, causando satisfação em quem lhe confiou a possibilidade de prestar serviço.

LANÇAMENTO DE PEÇAS 2017/2018

Consulte nossos vendedores, faça sua cotação e conheça o que a Cotral tem para você!

Av. Aracaju, 556 - Riachuelo
Ji-Paraná, RO - CEP: 76913-780

 3423 7878 | 7800

 cotralpeças@hotmail.com

 rosanerocha@hotmail.com

Resistência e durabilidade,
a melhor ferramenta
para o seu
trabalho.

MODELO RA - 143L

Raisman®

A maior fábrica de peças do Brasil



BOMBINES

Bombines para injeção do combustível que facilita a partida da roçadeira, mesmo em condições adversas como frio e baixa pressão.



CAIXA DE ENGRENAGEM

Robusta proporcionando maior resistência e maior durabilidade, mesmo em trabalhos contínuos.



CARBURADOR

O carburador de borboletas possui três sistemas de regulagens: Parafusos de Regulagem de Marcha Lenta, Parafuso de Regulagem de Baixa (L), Parafuso de Regulagem de Alta (H). Possibilitando assim um ajuste mais preciso nos regimes de trabalho do motor diante das variações encontradas no uso do equipamento que afetam o seu desempenho, tais como:
- Qualidade dos Combustíveis;
- Variações Climáticas e Geográficas: Variações de Temperatura e Pressão Atmosférica (Devido a Variação de Altitude).



FIXAÇÃO DO GUIDON

Elaborada em alumínio para resistir ao desgaste e ao impacto.



PUNHO

Confeccionado com botão de auto bloqueio para facilitar destravamento em casos de emergência.



PROTEÇÃO DE CORTE

Proteção fixada na caixa de engrenagem, mais robusta, confeccionada em material resistente ao impacto que propicia maior segurança ao operador.



TANQUE DE COMBUSTÍVEL

Melhor dimensionado o que propicia uma maior autonomia em trabalhos extensos.

PROTEÇÃO DO TANQUE

Evita deformação e desgaste por atrito, dando maior proteção ao armazenamento do combustível



CARENAGEM DO MOTOR

Mais robusta e confeccionada em material altamente resistente. Garante uma roçadeira altamente resistente ao trabalho duro.



COTRAL

By Raisman®

www.raisman.com.br



CÓDIGO: 42-00-1T2L
CÓDIGO: 42-00-1T4L

FILTRO DE GASOLINA DIVERSOS



CÓDIGO: 42-00-ZF5
CÓDIGO: 42-00-ZF4
CÓDIGO: 42-00-ZF2

FILTRO DE GASOLINA DIVERSOS



CÓDIGO: 43-88-012

INJETOR DO CARBURADOR WALBRO (GRANDE)



CÓDIGO: 43-88-013

INJETOR DO CARBURADOR ZAMA (PEQUENO)



CÓDIGO: 46-00-H17

CARBURADOR ROÇADEIRAS CHINESAS
25-33CC-HUSQ.-142R-236R

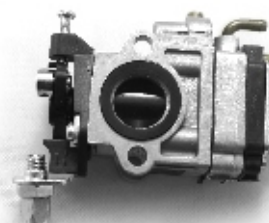

CÓDIGO: 46-06-CHW

CARBURADOR-ROÇADEIRAS-CHINESAS
43-52CC-HUSQ.142R-143RII



CÓDIGO: 63-30-241

MOLA DE EMBREAGEM HUSQVARNA 241R



CÓDIGO: 70-10-242

MOLA DE PARTIDA S-PRATO ROC 1331
143L ROÇ.HUSQ 142R.142RB 143R



CÓDIGO: 70-10-431

MOLA DE PARTIDA KAWASHIMA - TOYAMA - VULCAN



CÓDIGO: 70-17-000

MANIPULO UNIVERSAL (PUNHO DE PARTIDA)



CÓDIGO: 70-74-132

FILTRO DE AR HUSQVARNA 132



CÓDIGO: 70-74-241

FILTRO DE AR ROÇADEIRA HUSQVARNA 241



CÓDIGO: 70-75-033

JUNTA DO MOTOR COMPLETO ROÇADEIRA
33CC IMPORTADA ROC. 133L RAISMAN



CÓDIGO: 70-75-043

JUNTA DO MOTOR COMPLETO ROÇADEIRA
43CC IMPORTADA ROC. 143L RAISMAN



CÓDIGO: 70-80-580

JOGO DE PINHÕES MODELO NOVO STIHL 160 220-280



CÓDIGO: 73-90-139

CONJUNTO TRANSMISSÃO COMPLETA 28MM X09
ESTRIAS ROSCA M10X1.25 ESQUERDA



CÓDIGO: 74-02-265-LT

FACA 2 PONTAS LATTORK 330mm FURO 20mm
ESP. 2.65mm STIHL.FS 160-220-280



CÓDIGO: 74-02-266-LT

FACA 2 PONTAS LATTORK 330mm FURO 25.4mm ESP. 2.65mm
ST.85-86-108 HUSQ 132-142-143-235-236R-226R-243R



CÓDIGO: 74-02-334

FACA 2 PONTAS RAISMAN 330mm FURO 25.4mm ESP. 2mm
ST.85-86-108 HUSQ 132-142-143-235-236R-226R-243R



CÓDIGO: 74-02-732

FACA 2 PONTAS RAISMAN 330mm FURO 20mm
ESP. 2.7mm STIHL.FS 160-220-280



CÓDIGO: 74-10-142

PORCA DA FACA ROÇADEIRA
HUSQVARNA 132-142-235-240



CÓDIGO: 74-10-220

PORCA DA FACA ROÇ. STIHL 160-220-280



CÓDIGO: 74-10-225

PORCA DA FACA ROÇ. HUSQ. 225-232-323



CÓDIGO: 74-10-343

PORCA DA FACA COM FLANGE
HUSQ.-143R-241R-343R-236R



CÓDIGO: 74-99-010

PRATO GIRATÓRIO 16MM METAL STHIL 160 220 280



CÓDIGO: 74-99-010/N

PRATO GIRATÓRIO 16mm NYLON STHIL FS 160-220-280



CÓDIGO: 74-99-010/M

PRATO GIRATÓRIO NYLON 16MM
MACIÇO STHIL FS-160-220-280



CÓDIGO: 70-02-220

CONJUNTO TRANSMISSÃO COMPLETA FS 160
220-280- ROÇ. 133L 143L



CÓDIGO: M10-11-001

CILINDRO COMPLETO ROÇADEIRA 143L

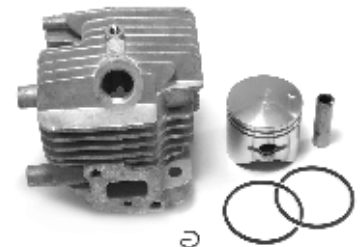

CÓDIGO: M10-11-005

CILINDRO COMPLETO ROÇADEIRA 125L



CÓDIGO: M10-12-001

PISTÃO COMPLETO ROÇ. 133L



CÓDIGO: M10-12-002

PISTÃO COMPLETO ROÇ. 143L



CÓDIGO: M10-14-001

VIRABREQUIM ROÇ. 143L



CÓDIGO: M10-20-001

CARBURADOR H18 ROÇADEIRA 143L



CÓDIGO: M10-41-001

TAMBOR DE EMBREAGEM RA 125L 26 ROÇADEIRA



CÓDIGO: M10-41-002

TAMBOR DA EMBREAGEM QUADRADO
ROÇ. 133L-143L-RAISMAN



CÓDIGO: M10-42-000

EMBREAGEM COMPLETA
ROÇADEIRA 133L-143L- RAISMAN



CÓDIGO: M10-42-000/1

MOLA DE EMBREAGEM ROÇADEIRA 133L 143L



CÓDIGO: M10-42-001

EMBREAGEM COMPLETA ROÇ. IMPORTADA 125L-1426L



CÓDIGO: M10-51-004

PROTEÇÃO DO RESERVATÓRIO ROÇ. 143L



CÓDIGO: M10-53-001

PUNHO INTERRUPTOR CHICOTE ELÉTRICO



CÓDIGO: M10-54-000

CARÇA DA EMBREAGEM 133L / 143L



CÓDIGO: M10-54-002

CARÇA DO VIRABREQUIM ROÇADEIRA 143L



CÓDIGO: M10-54-005

CARÇA DO CILINDRO ROÇADEIRA 143L



CÓDIGO: M10-56-000

BASE DO FILTRO DE AR - ROÇADEIRA 133L



CÓDIGO: M10-83-001/LG

MOLA DE PARTIDA GROSSA / LARGA ROÇ. 133L - 143L



CÓDIGO: M10-57-000

TAMPA DE RESERVATÓRIO DE COMBUSTÍVEL
ROÇ. 133L-143L



CÓDIGO: M10-57-002

TANQUE COMBUSTÍVEL ROÇ. 143L



CÓDIGO: M10-61-002

SUPORE DO TUBO E GUIDÃO (COMPLETO)
ROÇ. 133L-143L



CÓDIGO: M10-63-000

CABO ACELERADOR ROÇADEIRA 133L-143L



CÓDIGO: M10-64-001

CONECTOR DO CARBURADOR (FLANGE) ROÇ. 143L 43CC



CÓDIGO: M10-65-001

CONJUNTO VEDAÇÃO + MANGUEIRA COMBUSTÍVEL
ROÇ. IMPORTADA 143L-133L



CÓDIGO: M10-66-003

CHAVE INTERRUPTORA RA - 133L-143L



CÓDIGO: M10-73-000

TERMINAL DA VELA COM CABO ROÇ. 133L-143L



CÓDIGO: M10-74-001

VOLANTE ELETRÔNICO ROÇADEIRA 143L



CÓDIGO: M10-80-000

ARRUELA ESTRIADA ROÇ. 133L-143L



CÓDIGO: M10-80-001

PROTEÇÃO ARRUELA ROÇ. 133L-143L



CÓDIGO: M10-80-002

ARRUELA DE MONTAGEM
ROÇ. 133L-143L ROÇ. 160-220-280



CÓDIGO: M10-80-003

ACOPLAMENTO DA PARTIDA COMPLETO
ROÇ. 133L-143L



CÓDIGO: M10-80-004

ACOPLAMENTO DO TUBO ROÇ. 133L-143L



CÓDIGO: M10-80-005

DEFLETOR DE CALOR ROÇADEIRA 133L

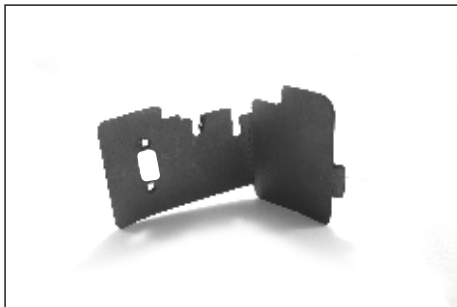

CÓDIGO: M10-80-006

DEFLETOR DE CALOR ROÇADEIRA 143L



CÓDIGO: M10-80-007

BOMBINES INJETOR DE COMBUSTÍVEL ROÇ. 133L-143L



CÓDIGO: M10-81-001

FILTRO DE AR REFORÇADO
ROÇ. 143L PADRÃO ORIGINAL



CÓDIGO: M10-81-001-1

FILTRO DE AR ROÇ. 143L ESPUMA



CÓDIGO: M10-83-006

CONJUNTO TAMPA PARTIDA COMPLETA 133L-143L



CÓDIGO: M10-97-000

JUNTA DA CARÇAÇA ROÇADEIRA 133L



CÓDIGO: M10-97-002

JUNTA CILINDRO ROÇ. 143L



CÓDIGO: M10-97-003

JUNTA DO CONDUTOR (FLANGE) ROÇADEIRA 133L



CÓDIGO: M10-97-004

JUNTA DE VEDAÇÃO DO CARBURADOR
ROÇADEIRA 133L



CÓDIGO: M10-97-005

JUNTA DA CARÇAÇA ROÇADEIRA 143L

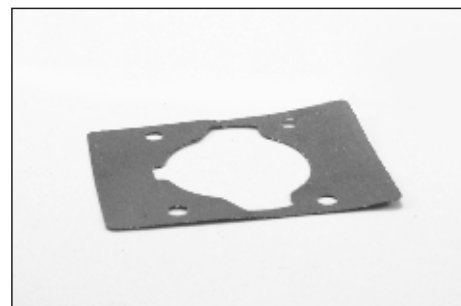

CÓDIGO: M10-97-006

JUNTA DO CILINDRO ROÇ. 133L

FIO DE NYLON



CÓDIGO	DESCRIÇÃO	APLICAÇÃO
72-18-200	FIO DE NYLON 1.8 REDONDO	BOBINA C/ 2KG APROX. 640MTS
72-25-200	FIO DE NYLON 2.5 REDONDO	BOBINA C/ 2KG APROX. 320MTS
72-25-201	FIO DE NYLON 2.5 QUADRADO	BOBINA C/ 2KG APROX. 270MTS
72-27-200	FIO DE NYLON 2.7 REDONDO	BOBINA C/ 2KG APROX. 300MTS
72-27-201	FIO DE NYLON 2.7 QUADRADO	BOBINA C/ 2KG APROX. 320MTS
72-30-200	FIO DE NYLON 3.0 REDONDO	BOBINA C/ 2KG APROX. 250MTS
72-30-201	FIO DE NYLON 3,0 QUADRADO	BOBINA C/ 2KG APROX. 210MTS



CÓDIGO: 70-01-220

JUNTA DE VEDAÇÃO DO CARBURADOR
ROÇADEIRA 133L



CÓDIGO: M81-88-000

CONJUNTO CINTO PULVERIZADOR



CÓDIGO: M10-83-001/LG

MOLA DE PARTIDA GROSSA / LARGA ROÇ. 133L - 143L





CÓDIGO	DESCRIÇÃO	APLICAÇÃO
BPM7A	VELA BPM7A - NGK	MOTOSSERRAS STHIL / HUSQ -CURTA
BPM6A	VELA BPM6A - NGK	MOTOSSERRAS STHIL / HUSQ -CURTA
BPMR7A	VELA BPRM7A - NGK	ATOMIZADOR STHIL / HUSQ RAISMAN -CURTA
BPR6ES	VELA BPR6ES - NGK	MOTORES ESTACIONÁRIOS / RONBIN / HONDA BRANCO E PLACA VIBRATÓRIA
B6HS	VELA B6HS - NGK	STHIL 08 (ANTIGA / LONGA)
B8HS	VELA B8HS - NGK	GERADORES / CORTADOR DE GRAMA ATOMIZADORES / QUADRÍCULO / KASINSKI
BP6ES	VELA BP6HS - NGK	MOTORES ESTACIONADOS - ROBIN / HONDA BRANCO / PLACA VIBRATÓRIA
BP6HS	VELA BP6HS - NGK	MOTORES ESTACIONÁRIOS / RONBIN / HONDA BRANCO E PLACA VIBRATÓRIA
B7HS	VELA B7HS - NGK	GERADORES, CORTADOR DE GRAMA, ATOMIZADORES, COMPACTADOR SOLO
B7HS/10	VELA B7HS/10 - NGK	MOTOR POPA 15 Á 40 HP/ YAMAHA
CMR5H	VELA CMR5H - NGK	HUSQVARNA TODAS 2001 / 2011 / 3241X SERIES / HONDA 1,5 HP GX35
CMR6H	VELA CMR6H - NGK	HUSQVARNA 345
CMR6A	VELA CMR6A - NGK	SOPRADORES
CMR7H	VELA CMR7H - NGK	CORTADORES CERCA VIVA, HUSQVARNA T435



DISTRIBUIDOR AUTORIZADO

10

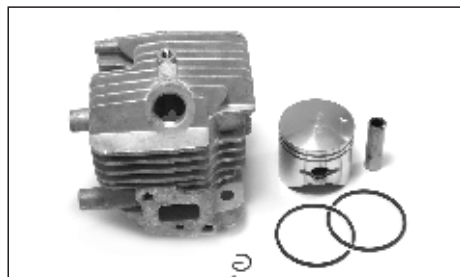

CÓDIGO: M10-11-005

CILINDRO COMPLETO PULVERIZADOR 25cc
ROÇADEIRA CHINESA 25cc



CÓDIGO: M10-12-004

PISTÃO COMPLETO DO PULVERIZADOR 25cc
ROÇADEIRA CHINESA 25cc



CÓDIGO: M10-71-002

MÓDULO IGNIÇÃO PULVERIZADOR
ROÇADEIRA CHINESA 25cc



CÓDIGO: M10-80-009

ACOPLAMENTO DA PARTIDA
SOPRADOR E PULVERIZADOR 25cc



CÓDIGO: M10-83-007

CONJ. TAMPA DE PARTIDA PULVERIZADOR 25cc



CÓDIGO: M81-55-006

TAMPA DO RECIPIENTE DO PULVERIZADOR 25cc



CÓDIGO: M81-63-000

LANÇA MONO JATO PULVERIZADOR 25cc

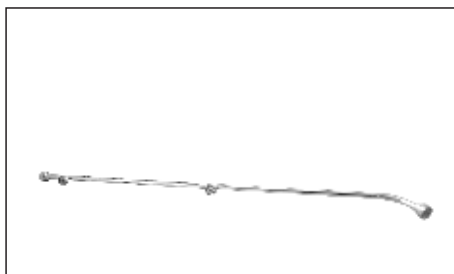

CÓDIGO: M81-63-001

LANÇA MULTI JATO 25cc

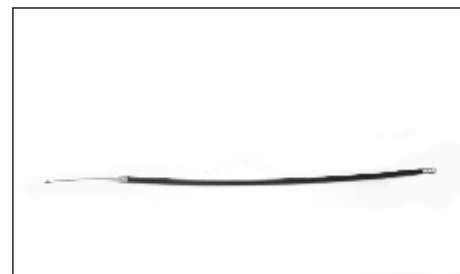

CÓDIGO: M90-63-000

CABO DO ACELERADOR PULVERIZADOR 25cc



CÓDIGO: M80-81-003/1

INTERRUPTOR PULVERIZADOR 25cc

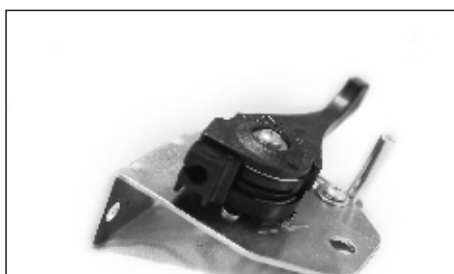

CÓDIGO: M80-81-003

ACELERADOR PULVERIZADOR 25cc



CÓDIGO: M81-80-006

VÁLVULA DE CONTROLE DE FLUXO



CÓDIGO: 19810720

CONJUNTO RETRÁTIL COMPLETO
(TAMPA DE PARTIDA) 5.5 6.5 7.0 HP



CÓDIGO: 98-20-600

SANFONA COMPACTADOR 160mm X 250mm ALTURA
*CONSULTE DEMAIS MODELOS

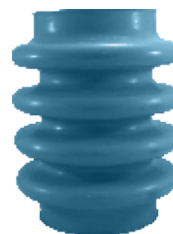

CÓDIGO: 98-20-620

SANFONA COMPACTADOR 140mm X 245mm ALTURA
*CONSULTE DEMAIS MODELOS



CÓDIGO: M81-97-000

JUNTA DE VEDAÇÃO DO RECIPIENTE
PULVERIZADOR 25CC



CÓDIGO: M81-80-006/M

MANGUEIRA DO PULVERIZADOR RA-525P-14



CÓDIGO: 80-30-500

FILTRO DE AR HONDA GX100 BRIGGS 3,5 HP



CÓDIGO: 80-30-912

FILTRO DE AR ROBIN EH-12



CÓDIGO: M81-80-007

BOMBA DE PRESSÃO PULVERIZADOR RA - 525P-14



CÓDIGO: M90-90-090

KIT REPARO COM RETENTOR BOMBA DE ÁGUA RA-643B1,5



CÓDIGO: 80-40-901

TAMPA DE PARTIDA ROBIN EY20



CÓDIGO: M20-57-001/T

TORNEIRA UNIVERSAL DO TANQUE DO COMPACTADOR



CÓDIGO: M20-57-001

TANQUE COMBUSTÍVEL COMPACTADOR ROBIN EH12



CÓDIGO: 43-10-031

KIT REPARO DO CARBURADOR STHIL 170-180



CÓDIGO: 46-06-170

CARBURADOR STHIL 170-180



CÓDIGO: 61-00-170

PISTÃO COMPLETO 37mm STHIL MS 170



CÓDIGO: 61-00-180

PISTÃO COMPLETO 38mm STHIL MS 180



CÓDIGO: 63-10-517

EMBREAGEM COMPLETA STHIL 250/025/210/180/170



CÓDIGO: 63-30-525

MOLA DE EMBREAGEM STHIL 025-170-180



CÓDIGO: 70-13-003

PEÇA DE ENGATE CACHORRETE STHIL 025-034-018-170-180



CÓDIGO: 70-15-518

TAMPA DE PARTIDA COMPLETA STHIL 170-180



CÓDIGO: 70-15-525

POLIA PARTIDA STHIL 025/250/170/180



CÓDIGO: 70-73-525

BOMBA DE OLEO STHIL 025/250/210/230/170/180



CÓDIGO: 70-74-025

SEM-FIM STHIL 170-180 025-250



CÓDIGO: 70-76-518

TAMPA DO PINHÃO STHIL 170-180 025-250



CÓDIGO: 70-31-170

TAMPA DO TANQUE GASOLINA E OLEO STHIL 170



CÓDIGO: 64-00-170

VIRABREQUIM STHIL 170



CÓDIGO: 70-74-517

SEM FIM STHIL MS 180-170



CÓDIGO: 65-11-170

SUPORTE FILTRO STHIL 170



CÓDIGO: 70-15-170

COBERTURA DO CILINDRO STHIL 170

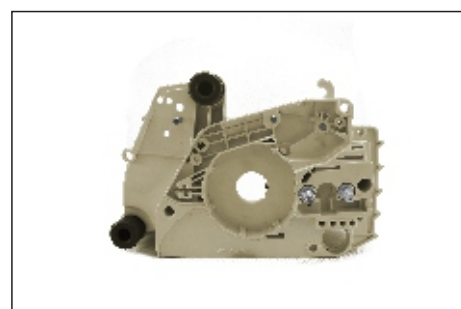

CÓDIGO: 70-00-170

CARCAÇA DO VIRABREQUIM STHIL 170



CÓDIGO: 65-12-570

MANGUEIRA DO ÓLEO STHIL 170



CÓDIGO: 65-18-170

MÓDULO ELETRÔNICO STHIL 170



CÓDIGO: 65-18-055

MÓDULO ELETRÔNICO STIHL FS38-HUSQ 45-55



CÓDIGO: 70-16-170

TANQUE COMBUSTÍVEL STHIL 170



CÓDIGO: 65-12-170

BUJÃO DO AMORTECEDOR STHIL 170

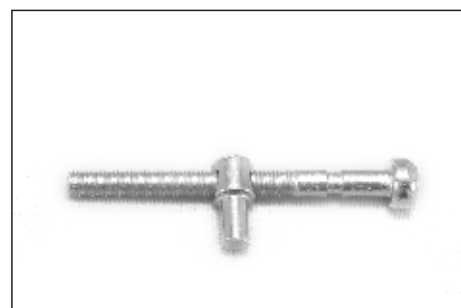

CÓDIGO: 70-70-009

PARAFUSO AJUSTE CORRENTE STHIL 170



CÓDIGO: 70-78--518

FILTRO DE AR STIHL 018 170-180



CÓDIGO: 70-85-518

SILENCIOSO STIHL 018 170-180



CÓDIGO: 76-30-566

PROTEÇÃO DE MÃO STIHL 066/660



CÓDIGO: 70-00-268

CARÇAÇA CPL VIRABREQUIM HUSQV. 61/268/272



CÓDIGO: 10-20-268/LT

SABRE 20" 36 DENTES HUSQ
*CONSULTE DEMAIS MODELOS



CÓDIGO: 80-95-053/1

TACÔMETRO DIGITAL LÊ ATÉ 9.000 RPMS

LIMAS/LIMATÃO CAVALINHO



**LIMAS REDONDAS
CHATAS E
PARA SERROTES**

**CONSULTE NOSSOS MODELOS E APLICAÇÕES DIVERSAS
LIMAS CAVALINHO, EXPERIMENTE E APROVE!**

15



CÓDIGO: M60-64-001

COTOVELO DO ATOMIZADOR E SOPRADOR RA 456A-14

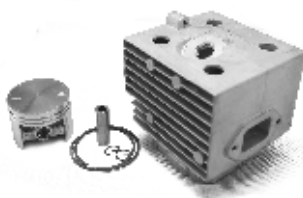

CÓDIGO: M60-11-000

CILINDRO COMPLETO ATOMIZADOR 56cc



CÓDIGO: M60-12-000

PISTÃO DO ATOMIZADOR 46mm 56cc



CÓDIGO: M60-20-000

CARBURADOR BORBOLETA ATOMIZADOR
RA 465A 14 56cc



CÓDIGO: M60-53-003

PUNHO DE CONTROLE COMPLETO
ATOMIZADOR SOPRADOR 56cc



CÓDIGO: M60-60-002/1

CABO DE LIGAÇÃO, CABO DO ACELERADOR E
MANGUEIRA ISOLANTE ATOMIZADOR E SOPRADOR



CÓDIGO: M60-64-006

CONECTOR DO CARBURADOR (FLANGE) DO ATOMIZADOR 56cc



CÓDIGO: M60-65-000

MANGUEIRA SANFONADA DO ATOMIZADOR 56cc

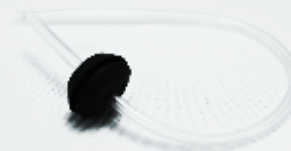

CÓDIGO: M60-65-002

MANGUEIRA DO RESERVATÓRIO DE
GASOLINA SOPRADOR E ATOMIZADOR 56cc

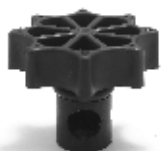

CÓDIGO: M80-67-010

VÁLVULA REGULADORA DO ATOMIZADOR 56cc



CÓDIGO: M60-69-000

TUBO DO ATOMIZADOR 56cc



CÓDIGO: M60-69-001

TUBO DO ATOMIZADOR 56cc



CÓDIGO: M60-75-000

MÓDULO DE IGNIÇÃO SOPRADOR ATOMIZADOR 56cc



CÓDIGO: M60-75-000/1

CACHIMBO + CABO DE VELA ATOMIZADOR 56cc



CÓDIGO: M60-81-000

FILTRO DE AR DO ATOMIZADOR 56cc



CÓDIGO: M60-83-000

SISTEMA DE ARRANQUE DO ATOMIZADOR 56cc



CÓDIGO: M60-83-002

RODA DO ARRANQUE SOPRADOR ATOMIZADOR
RA 256S RA 456A RAISMAN



CÓDIGO: M60-88-000

CONJUNTO CINTO SOPRADOR E ATOMIZADOR 56cc

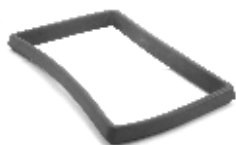

CÓDIGO: M60-95-002

JUNTA DE VEDAÇÃO DO FILTRO DE AR DO ATOMIZADOR 56cc



CÓDIGO: M80-55-005

TAMPA DO RECIPIENTE ATOMIZADOR 56cc



CÓDIGO: M80-61-005

CONEXÃO FLEXÍVEL DO AMOTIZADOR 56cc



CÓDIGO: M80-67-012

REGISTRO DO ATOMIZADOR 56CC RAISMAN



CÓDIGO: M80-69-006

BOCAL SIMPLES DO ATOMIZADOR 56cc



CÓDIGO: M80-69-007

TUBO DE RESPIRO DE AR ATOMIZADOR 56cc



CÓDIGO: M80-80-006

GRADE CÔNICA ATOMIZADOR 56cc



CÓDIGO: M80-80-007

GRADE DEFLETORA DUPLA DO ATOMIZADOR 56cc



CÓDIGO: M80-80-008

GRANDE DEFLETORA ATOMIZADOR 56cc



CÓDIGO: M80-93-004

PORCA DE ENGATE ATOMIZADOR RA 456A



CÓDIGO: M80-95-012

ANEL DE VEDAÇÃO DA TAMPA DO RECIPIENTE ATOMIZADOR 56cc



CÓDIGO: 72-12-350

CÓDIGO: 72-12-040

CÓDIGO: 72-12-050

CORDÃO DE PARTIDA
PADRÃO ORIGINAL LATTORK 2,8/3,5/4,0/5,0

DIVERSOS



CÓDIGO: 81-79-000

TUBO GRAXA ALTA TEMPERATURA LITIO COM BISSULFETO



CÓDIGO: 81-79-001

TUBO GRAXA GRAFITADA 150g



CÓDIGO: 87-15-000

ÓLEO 2T ARBOR POWER 500ML
1/2L x 25L - 1LT x 50L - VERDE LÍMPIDO API TCI



CÓDIGO: 70-20-360

CHAVE COMBINADA PONTA TORKS 13X19



CÓDIGO: 70-20-319

CHAVE COMBINADA HUSQVARNA TODOS



CÓDIGO: 70-20-319-1

CHAVE COMBINADA HUSQ 13X19X60 (MENOR)

COTRAL

Husqvarna®



CARRETEL / TRIMMY M12

CÓDIGO : 578446401

DESCRIÇÃO : CARRETEL/TRIMMY M12

APLICAÇÃO : HUSQVARNA ORIGINAL ROÇ.

LAMINA CIRCULAR (SERRA)

CÓDIGO : 578442501

DESCRIÇÃO : LAMINA CIRCULAR (SERRA)

APLICAÇÃO : HUSQVARNA FURO 1"X 200MM/8"



LAMINA 2 PONTAS

CÓDIGO : 578445101

DESCRIÇÃO : LAMINA 2 PONTAS

APLICAÇÃO : HUSQVARNA FURO 1"X 330MM/13"

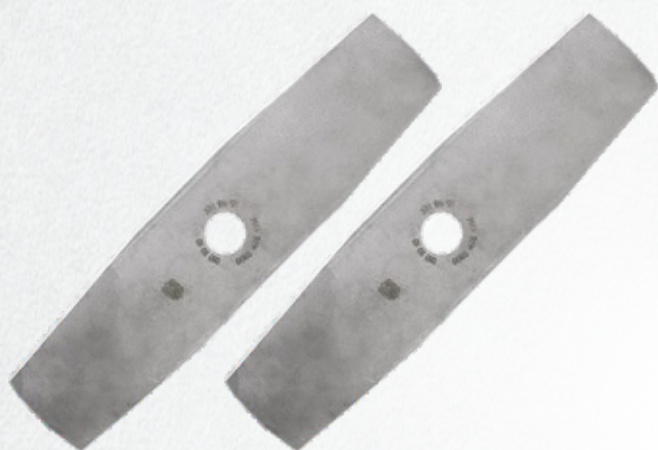

**DESENVOLVIDA EM PARCERIA
COM PROFISSIONAIS
FLORESTAIS**

**CONHEÇA A LINHA
DE CORTE ORIGINAL
HUSQVARNA**

DURABILIDADE - RENDIMENTO E QUALIDADE

COTRAL

By Raisman®

Raisman®

NGK

PLATT®

Husqvarna

MAGNETRON

YANMAR

LATTORK

Robin
SUBARU



3423 7878 | 7800



cotralpeças@hotmail.com



rosanerocha@hotmail.com



Av. Aracaju, 556 - Riachuelo - Ji-Paraná, RO - CEP: 76913-780